



## LED Floodlight EcoMax Color

### Features

- Four color options available
- Slim&Compact design
- Robust housing and refined finish coating
- IP66,IK08,30Khrs long lifespan

### Benefits

- Suitable for various applications
- Excellent thermal management for stable performance
- Long life, low maintenance cost
- Vibration-proof, Wind-proof, Rust-proof

### Application

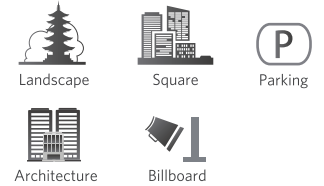

### Specification

Item Code	Item Description	Power (W)	Power Factor	Lumen (lm)	Efficacy (lm/W)	Input Current (mA)	Lifetime (L70B50)	MOQ (pcs)
543017028010	LED floodlight-E II 20W-A-GY-GP	20W	0.95	1900	95	90	30000	108
543017027510	LED floodlight-E II 20W-R-GY-GP	20W	0.95	400	20	90	30000	108
543017027910	LED floodlight-E II 20W-G-GY-GP	20W	0.95	1400	70	90	30000	108
543017027810	LED floodlight-E II 20W-B-GY-GP	20W	0.95	200	10	90	30000	108
543017027610	LED floodlight-E II 35W-A-GY-GP	35W	0.95	3325	95	160	30000	108
543017028110	LED floodlight-E II 35W-R-GY-GP	35W	0.95	700	20	160	30000	108
543017028210	LED floodlight-E II 35W-G-GY-GP	35W	0.95	2450	70	160	30000	108
543017027710	LED floodlight-E II 35W-B-GY-GP	35W	0.95	350	10	160	30000	108
543017028310	LED floodlight-E II 50W-A-GY-GP	50W	0.95	4750	95	230	30000	108
543017028710	LED floodlight-E II 50W-R-GY-GP	50W	0.95	1000	20	230	30000	108
543017028510	LED floodlight-E II 50W-G-GY-GP	50W	0.95	3500	70	230	30000	108
543017028410	LED floodlight-E II 50W-B-GY-GP	50W	0.95	500	10	230	30000	108
543017028610	LED floodlight-E II 75W-A-GY-GP	75W	0.95	7125	95	340	30000	108
543017028810	LED floodlight-E II 75W-R-GY-GP	75W	0.95	1500	20	340	30000	108
543017028910	LED floodlight-E II 75W-G-GY-GP	75W	0.95	5250	70	340	30000	108
543017029010	LED floodlight-E II 75W-B-GY-GP	75W	0.95	750	10	340	30000	108
543017029110	LED Floodlight-E II 120W-A-60D-GY-GP	120W	0.95	11400	95	550	30000	100
543017029210	LED Floodlight-E II 120W-A-72+28D-GY-GP	120W	0.95	11400	95	550	30000	100
543017029410	LED Floodlight-E II 160W-A-60D-GY-GP	160W	0.95	15200	95	725	30000	100
543017029310	LED Floodlight-E II 160W-A-72+28D-GY-GP	160W	0.95	15200	95	725	30000	100

Technical Specifications	
Dimmable	No
Housing Colour	Grey
IP	IP66
IK	IK08
Driver integrated (Yes/No)	Yes
Glow wire test	650°C
Driver failure rate	1% at 5000h
Weight (kg/pc)	0.51/0.81/1.34/1.98/4.06/5.01

Electrical Supply	
Frequency (Hz)	50/60
Voltage (V)	220-240
AC/DC	AC

Mechanical Properties	
Housing Material	Aluminium
Optical Material	Polycarbonate

Application Conditions	
Operating Temperature	-40-45°C
Application Temperature	25°C
Storage Environment	-40-65°C

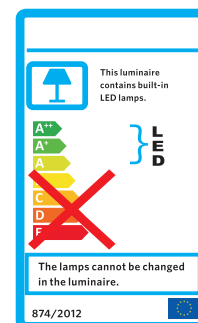

## Packaging Information

Item		Single Box(1pc/box)		Storage Environment		
Item Code	Item Description	Dimensions(mm) (LxWxH)	Gross Weight (kg)	Dimensions(mm) (LxWxH)	Gross Weight (kg)	Packing Qty (pcs/unit)
543017028010	LED floodlight-E II 20W-A-GY-GP	155*125*82	0.63	400*330*266	11.34	18
543017027510	LED floodlight-E II 20W-R-GY-GP	155*125*82	0.63	400*330*266	11.34	18
543017027910	LED floodlight-E II 20W-G-GY-GP	155*125*82	0.63	400*330*266	11.34	18
543017027810	LED floodlight-E II 20W-B-GY-GP	155*125*82	0.63	400*330*266	11.34	18
543017027610	LED floodlight-E II 35W-A-GY-GP	205*145*82	0.97	430*310*266	11.64	12
543017028110	LED floodlight-E II 35W-R-GY-GP	205*145*82	0.97	430*310*266	11.64	12
543017028210	LED floodlight-E II 35W-G-GY-GP	205*145*82	0.97	430*310*266	11.64	12
543017027710	LED floodlight-E II 35W-B-GY-GP	205*145*82	0.97	430*310*266	11.64	12
543017028310	LED floodlight-E II 50W-A-GY-GP	275*205*98	1.68	430*290*324	10.1	6
543017028710	LED floodlight-E II 50W-R-GY-GP	275*205*98	1.68	430*290*324	10.1	6
543017028510	LED floodlight-E II 50W-G-GY-GP	275*205*98	1.68	430*290*324	10.1	6
543017028410	LED floodlight-E II 50W-B-GY-GP	275*205*98	1.68	430*290*324	10.1	6
543017028610	LED floodlight-E II 75W-A-GY-GP	305*245*98	2.39	510*320*324	14.35	6
543017028810	LED floodlight-E II 75W-R-GY-GP	305*245*98	2.39	510*320*324	14.35	6
543017028910	LED floodlight-E II 75W-G-GY-GP	305*245*98	2.39	510*320*324	14.35	6
543017029010	LED floodlight-E II 75W-B-GY-GP	305*245*98	2.39	510*320*324	14.35	6
543017029110	LED Floodlight-E II 120W-A-60D-GY-GP	338*65*415	4.55	432*290*362	18.19	4
543017029210	LED Floodlight-E II 120W-A-72+28D-GY-GP	338*65*415	4.55	432*290*362	18.19	4
543017029410	LED Floodlight-E II 160W-A-60D-GY-GP	382*65*460	5.64	480*290*406	22.54	4
543017029310	LED Floodlight-E II 160W-A-72+28D-GY-GP	382*65*460	5.64	480*290*406	22.54	4

## Dimensional Drawing

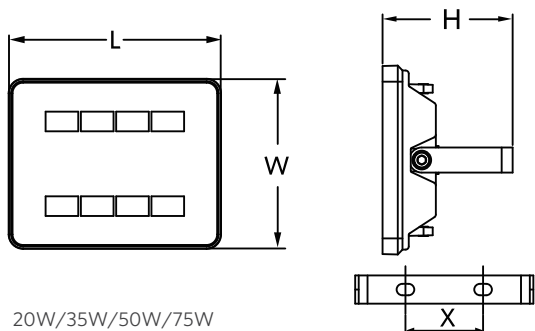

20W/35W/50W/75W

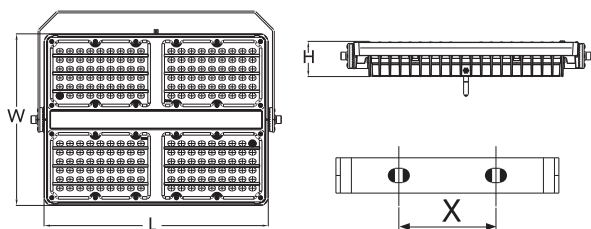

120W/160W

Model	L (mm)	W (mm)	H (mm)	X (mm)
LED FL-E 20W C	150	120	83	44
LED FL-E 35W C	200	140	99	60
LED FL-E 50W C	250	180	120	60
LED FL-E 75W C	280	220	135	80
LED FL-E 120W C	342	257	59	180
LED FL-E 160W C	376	288	59	200

## Photometric Data

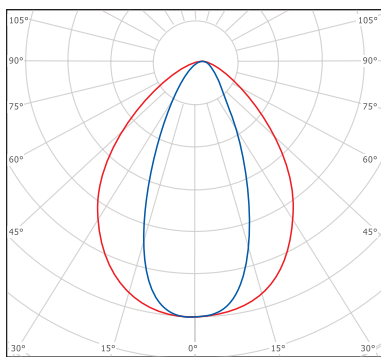

— C0 - C180 — C90 - C270

40°+80° (30W/50W/70W/100W)

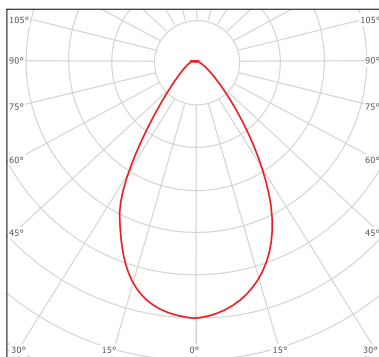

— C0 - C180 — C90 - C270

60° (150W/200W)

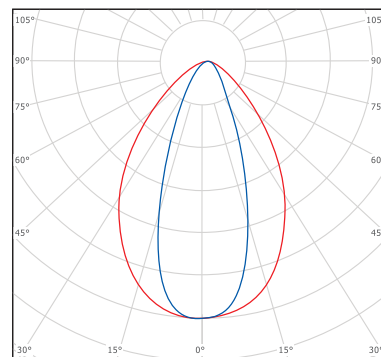

— C0 - C180 — C90 - C270

72°+28° (150W/200W)

### OPPLE SHANGHAI OFFICE

Building V3, The Mixc, 1799 Wuzhong Road,  
Minhang District, Shanghai, China

ZIP: 201103

T +86 21 3855 0000

E intersales@opple.com

[WWW.OPPLE.COM/EN](http://WWW.OPPLE.COM/EN)